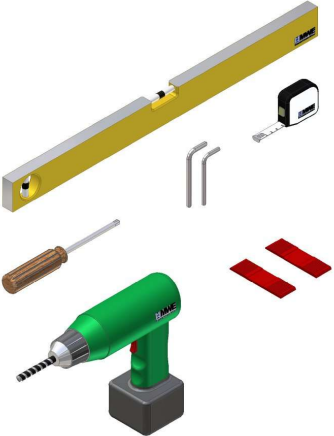
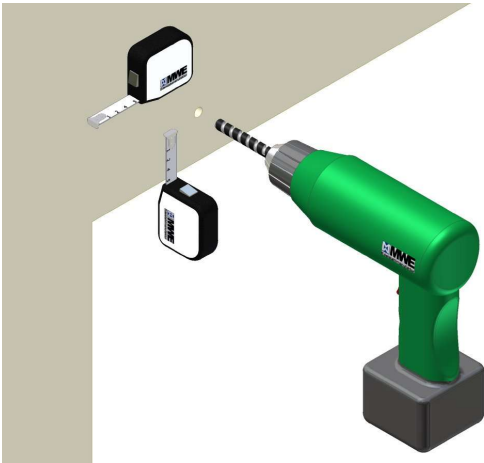
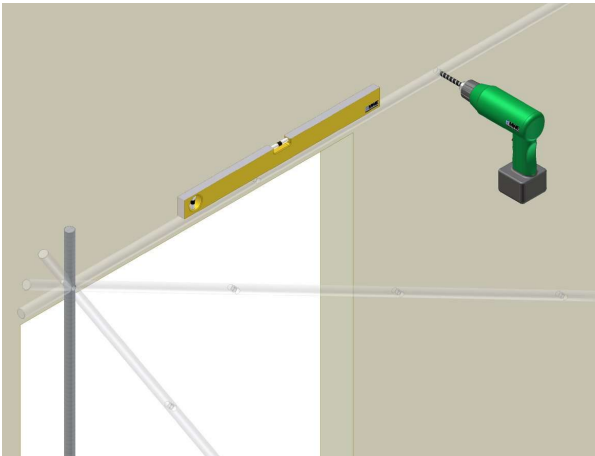

Installation instructions

System Protec (ST.1016.PR)

Am Steinbusch 7
D - 48351 Everswinkel
Tel.: +49(0)2582-9960- 0
Tel.: +49(0)2582-9960-128
Internet: www.mwe.de

	<h2>Tools</h2> <ul style="list-style-type: none">- water level- measuring tape- power drill- drill (\varnothing 1: 8 mm; \varnothing 2: 10 mm)- crosstip screwdriver- allen key set- jaw wrench (size: 10 mm)- pads <p>Please carefully read power drill safety instructions before installation.</p>
	<h2>1</h2> <h3>First wall drilling</h3> <p>Please use the water level to detect the highest point from finished floor level before making the first wall drilling. Use this point as a center line for the rail and arrange the attachment points in accordance with the drawing. The first drilling can be done now.</p>
	<h2>2</h2> <h3>Further wall drillings</h3> <p>Please loosely fix the first wall mount (see step 3). Put the rail into horizontal position and use it like a "stencil" to pre-drill further wall drillings. Drill \varnothing = 8 mm. Use a drill at \varnothing = 10 mm to redrill the holes and make them suitable for anchors.</p>

Installation instructions

System Protec (ST.1016.PR)

Am Steinbusch 7
D - 48351 Everswinkel
Tel.: +49(0)2582-9960- 0
Tel.: +49(0)2582-9960-128
Internet: www.mwe.de

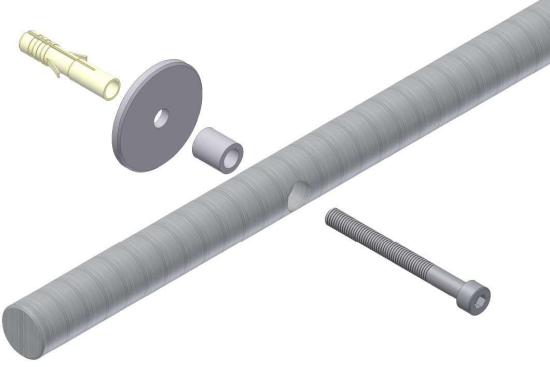
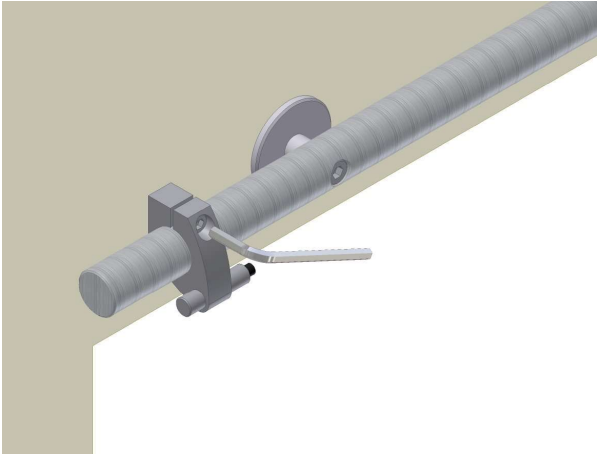
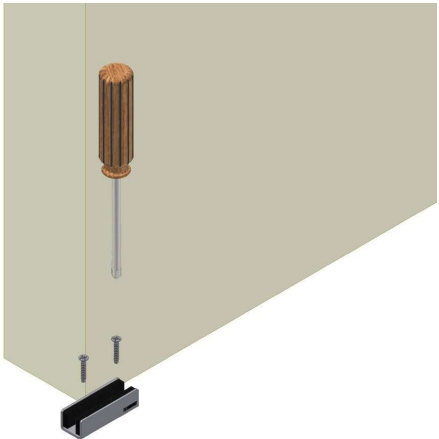
	<p>3 Mounting the rail</p> <p>Please use enclosed mounting elements to attach the rail at the wall.</p>
	<p>4 Mounting the door stops</p> <p>Secure door stoppers on the left and on the right side of runner rail in a way that will prevent the sliding door from rolling off the rail.</p>
	<p>5 Mounting the floor guide</p> <p>Fix the floor guide according to your planning detail using MWE installation material. Door leaf should slide parallelly to the wall in adjusted distance.</p>

Installation instructions

System Protec (ST.1016.PR)

Am Steinbusch 7
D - 48351 Everswinkel
Tel.: +49(0)2582-9960- 0
Tel.: +49(0)2582-9960-128
Internet: www.mwe.de

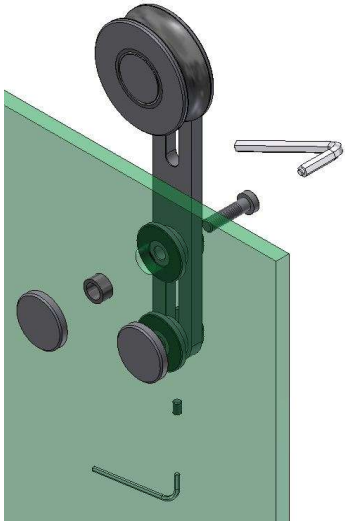
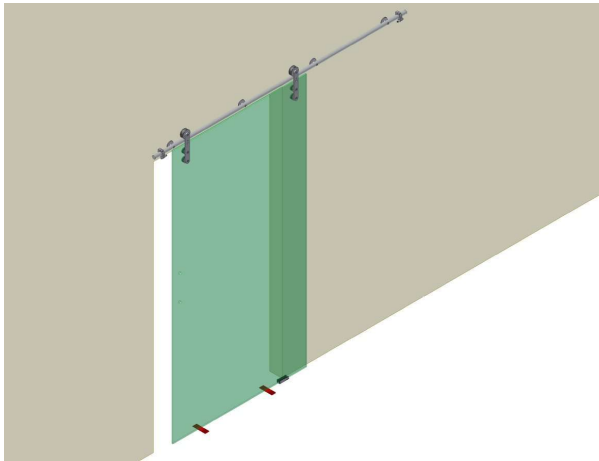
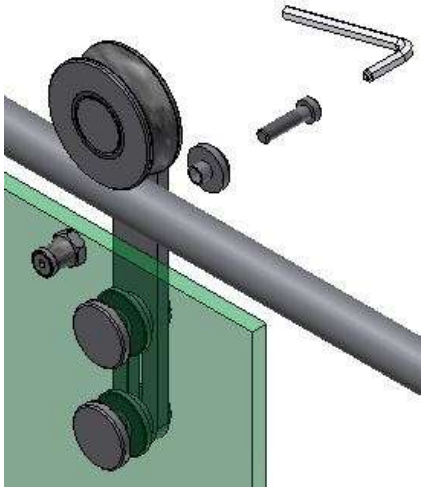
	<p>6 Mounting the carriages</p> <p>Rest Door leaf on mounting rests with the hardware facing upwards. Disassemble roller, security bolt and glass mounts. Attention: security bolt and swivel joint form one single unit. Hold glass mount spacers to holes. Apply roller shank including mounting bolts and secure from the opposite side using the glass fastening covers. Attention: Do not lose plastic bushings of glass mounts.</p>
	<p>7 Hinging the door leaf</p> <p>Hinge preassembled sliding door onto the rail. For safety reasons and for adjustment of floor distance (7 mm) put the pads on the floor underneath the door leaf. Mind the preassembled floor guide! Pads are to be removed afterwards.</p>
	<p>8 Mounting the safety pin</p> <p>Reassemble safety pin to the roller by using the jaw wrench (10 mm). Adjust the long hole. Attention: Do not leave any space between safety bolt and runner rail.</p>

Installation instructions

System Protec (ST.1016.PR)

Am Steinbusch 7
D - 48351 Everswinkel
Tel.: +49(0)2582-9960- 0
Tel.: +49(0)2582-9960-128
Internet: www.mwe.de

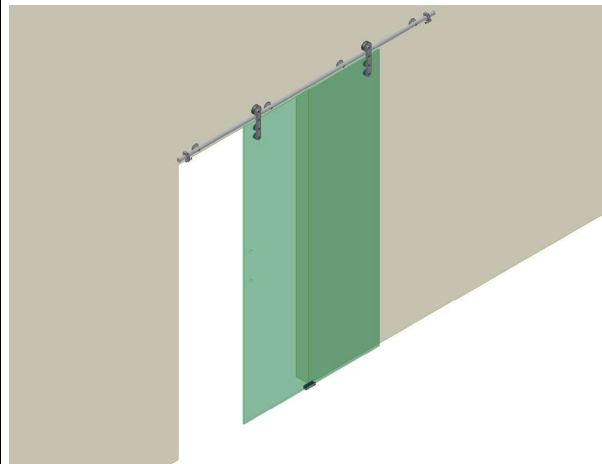

9

Final control of the sliding door

Control smooth sliding of the door and functionality of the door stops. Adjust door stops, if necessary. Secure stopper bolts tightly! Now you can install the door pulls.

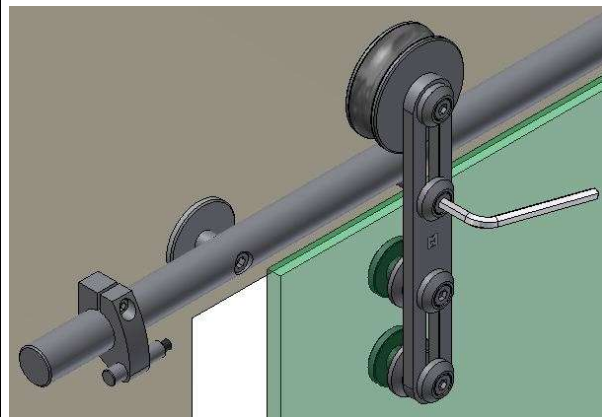

10

Tightening the bolts

Once the installation is completed make sure that every single bolt is once again securely tightened!