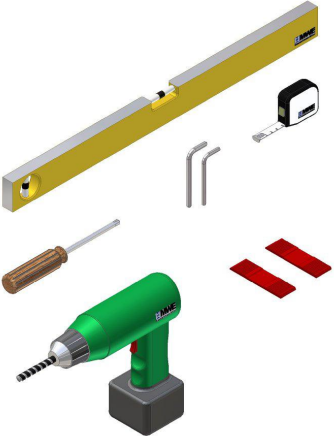
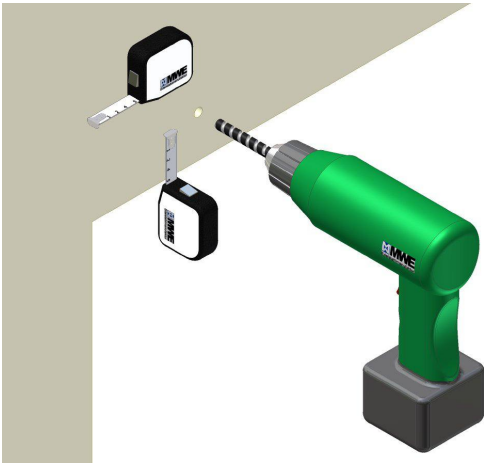
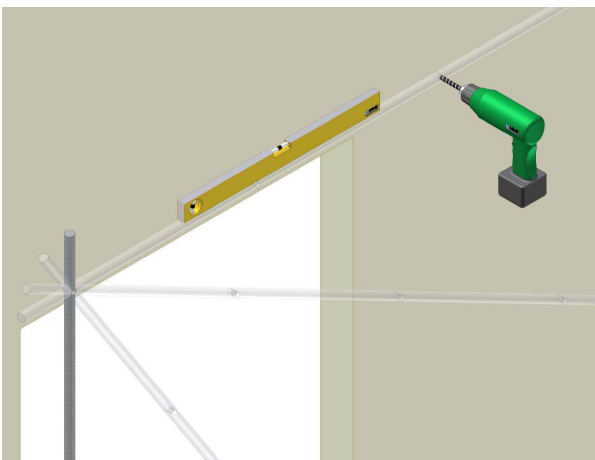

# Installation Instruction

System Duplex S (ST.1017.DS)

Am Steinbusch 7  
D - 48351 Everswinkel  
Tel.: +49(0)2582-9960- 0  
Tel.: +49(0)2582-9960-128  
Internet: [www.mwe.de](http://www.mwe.de)

	<h2>Tools</h2> <ul style="list-style-type: none"><li>- water level</li><li>- measuring tape</li><li>- power drill</li><li>- drill (diameter 1: 8 mm; diameter 2: 10 mm)</li><li>- crosstip screwdriver</li><li>- allen key set</li><li>- jaw wrench (size: 10 mm)</li><li>- glass shims</li></ul> <p>Please read power drill safety instructions carefully before installation.</p>
	<h2>1</h2> <h3>First Wall Hole</h3> <p>Drill hole for outer runner rail mount into wall according to your planning detail.</p>
	<h2>2</h2> <h3>Further Wall Holes</h3> <p>Mount loosely outer wall fasteners for runner rail (see step 3). Adjust runner rail into horizontal position using water level. Use runner rail as your "drilling template" to drill all necessary fastening holes with 8 mm drill. Use 10 mm drill to widen holes for anchors.</p>

# Installation Instruction

System Duplex S (ST.1017.DS)

Am Steinbusch 7  
D - 48351 Everswinkel  
Tel.: +49(0)2582-9960- 0  
Tel.: +49(0)2582-9960-128  
Internet: [www.mwe.de](http://www.mwe.de)

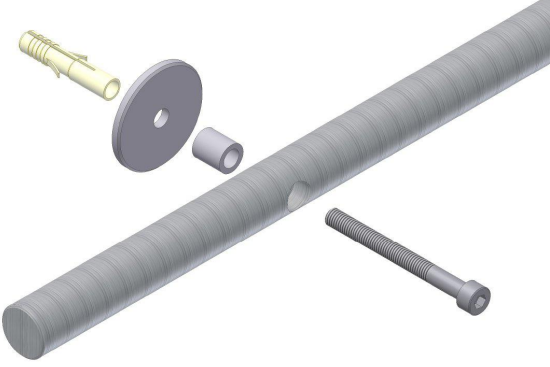
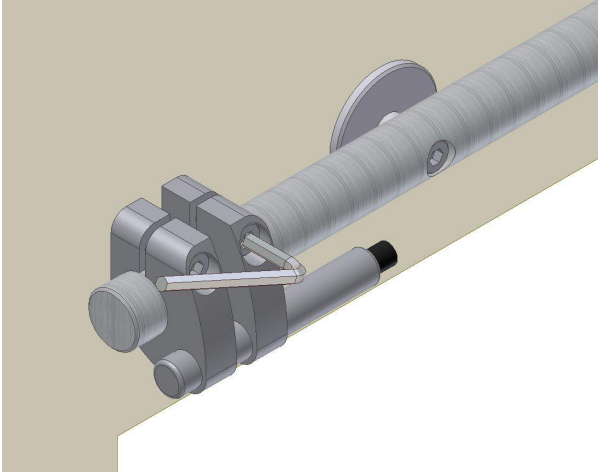
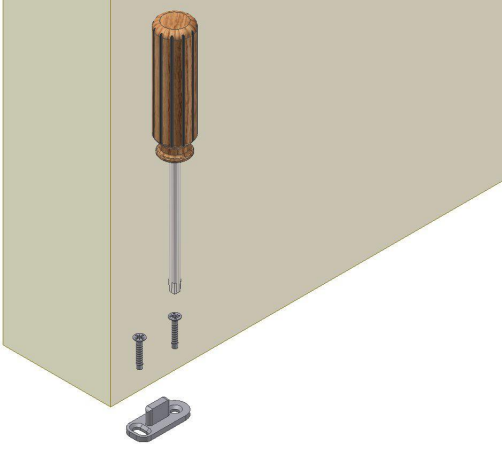
	<p><b>3</b> <b>Wall Fastening of Runner Rail</b></p> <p>Mount runner rail to wall with MWE mounting material.</p>
	<p><b>4</b> <b>Installation of Stopper</b></p> <p>Secure door stoppers on the left and on the right side of runner rail in a way that will prevent the sliding door from rolling off the rail.</p>
	<p><b>5</b> <b>Installation of Floor Guide</b></p> <p>Install floor guide according to your planning detail using MWE installation material. Door leaf must run in a parallel line to wall in given distance.</p>

# Installation Instruction

System Duplex S (ST.1017.DS)

Am Steinbusch 7  
D - 48351 Everswinkel  
Tel.: +49(0)2582-9960- 0  
Tel.: +49(0)2582-9960-128  
Internet: [www.mwe.de](http://www.mwe.de)

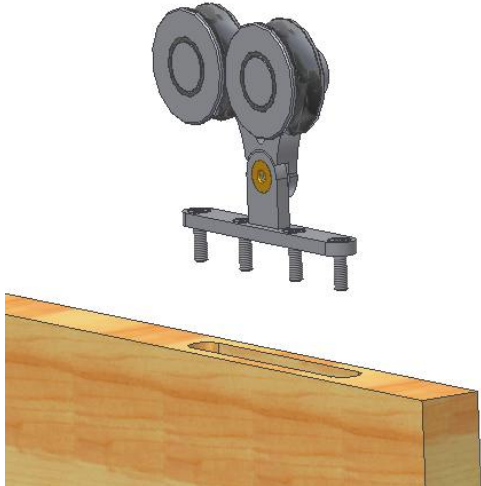
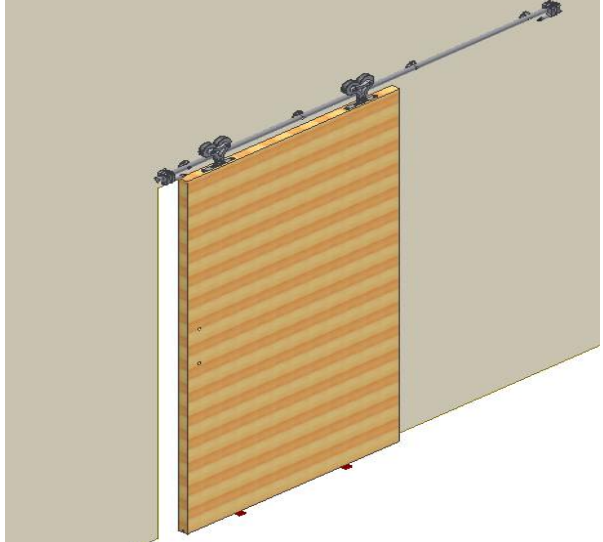
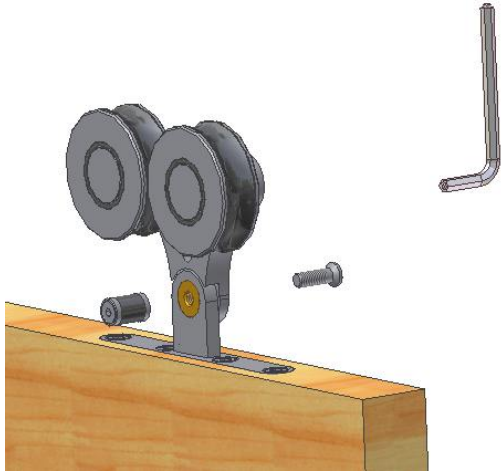
	<p><b>6</b> <b>Installation of Roller</b></p> <p>Rest Door leaf on mounting rests with the hardware facing upwards. Disassemble roller, security bolt and threaded bushings. Attention: the screw joint security bolt and roller pivot joint are one unit. Insert threaded bushings into wooden door leaf. Fit roller shank into countersunk position and screw it tightly into the threaded bushings using MWE mounting material.</p>
	<p><b>7</b> <b>Mounting of Door Leaf</b></p> <p>Hang preassembled sliding door onto the runner rail. For safety reasons and for adjustment of floor distance (7 mm) put the glass shims on the floor underneath the door leaf. Note preassembled floor guide! Glass shims are to be removed eventually.</p>
	<p><b>8</b> <b>Mounting of Safety Bolt</b></p> <p>Reassemble safety bolt to roller using jaw wrench (10 mm). Attention: do not leave space between safety bolt and runner rail. safety bolt must not scratch runner rail!</p>

# Installation Instruction

System Duplex S (ST.1017.DS)

Am Steinbusch 7  
D - 48351 Everswinkel  
Tel.: +49(0)2582-9960- 0  
Tel.: +49(0)2582-9960-128  
Internet: [www.mwe.de](http://www.mwe.de)

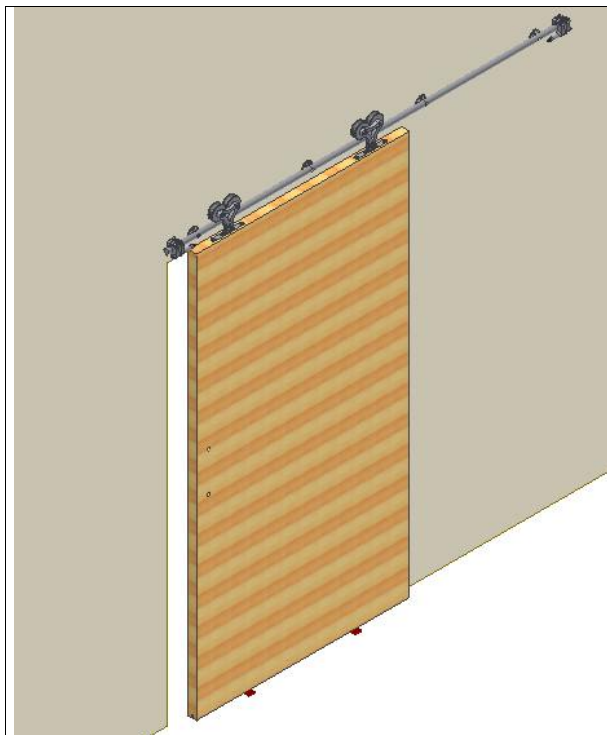

## 9

### Final Control of Sliding Door

Control smooth movement of sliding door and function of final door stops. Adjust door stops if necessary. Secure stopper bolts tightly!  
Install door handles or door knobs, respectively.

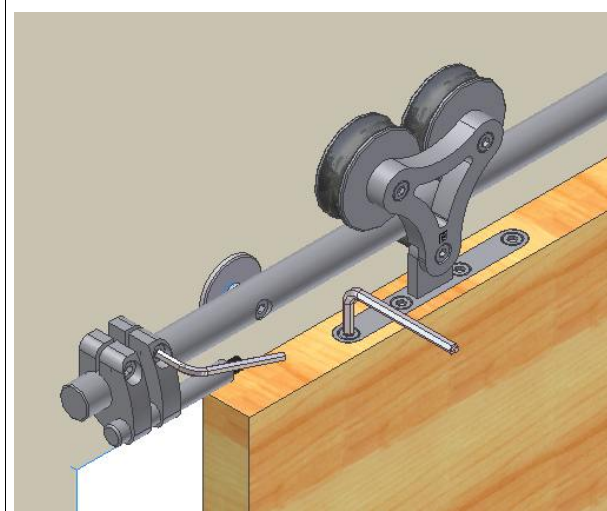

## 10

### Tightening of Bolts

After completion of installation make sure that every single bolt is once again securely tightened!