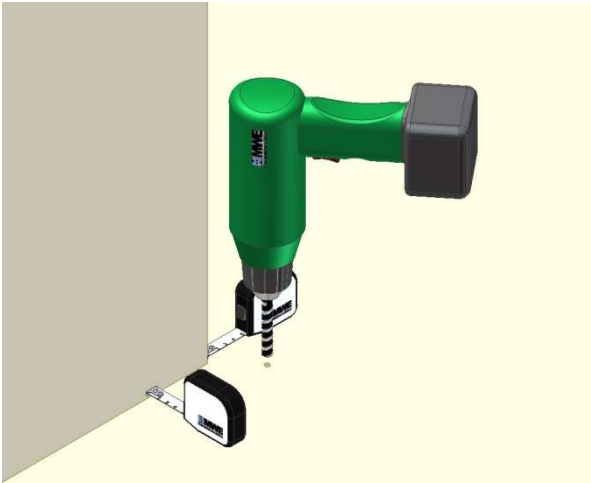
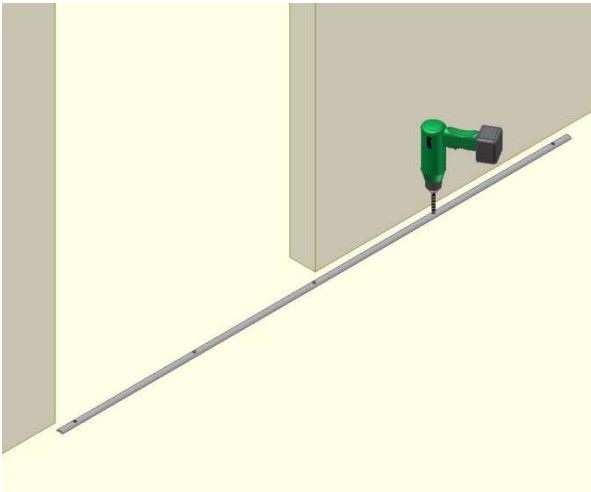

Installation instructions

System Terra M feat. Softstop (ST.1062.TM)

Am Steinbusch 7
D - 48351 Everswinkel
Tel.: +49(0)2582-9960- 0
Tel.: +49(0)2582-9960-128
Internet: www.mwe.de

	<p>Tools</p> <ul style="list-style-type: none">- water level- measuring tape / folding meter- power drill- stone drill bit D=4mm / D=6mm / D=10mm- crosstip screwdriver- allen key set- glass shimps <p>Please read power drill safety instructions carefully before installation.</p>
	<p>1 First floor drilling</p> <p>Drill the first hole for external rail fixation in accordance with your detailed planning. Use the 6 mm diameter drill.</p> <p>If construction glue is used (rail made without drillings!), please use the enclosed construction glue to stick down the rail onto the floor in accordance with the detailed planning. Attention – please follow the instructions for gluing! Steps # 2 and 3 are to be omitted.</p>
	<p>2 Further floor drillings</p> <p>Mount loosely the external fastening of the rail. See step # 3. Put the rail in a parallel position to the wall. Use the rail as your “drilling template” to pre-drill further holes by the 4 mm diameter drill. Redrill the holes by using 6 mm diameter drill.</p>

Installation instructions

System Terra M feat. Softstop (ST.1062.TM)

Am Steinbusch 7
D - 48351 Everswinkel
Tel.: +49(0)2582-9960- 0
Tel.: +49(0)2582-9960-128
Internet: www.mwe.de

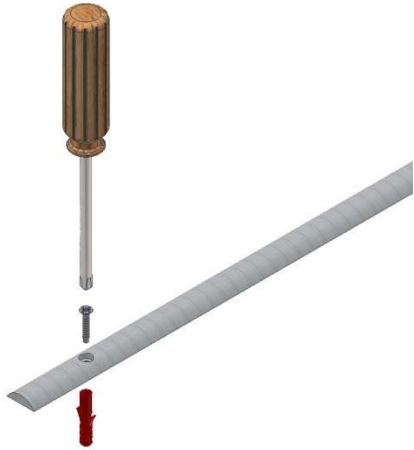
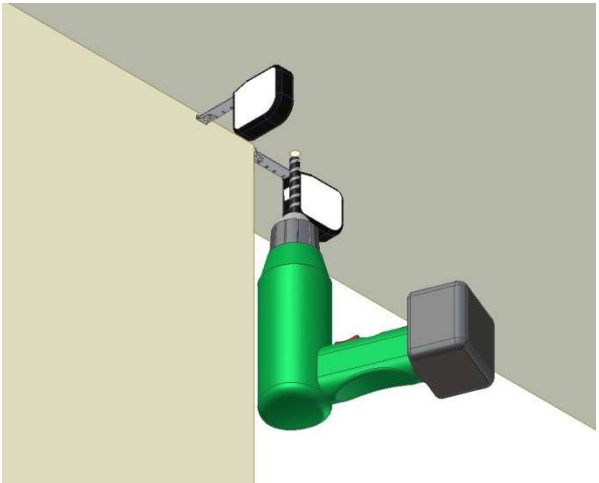
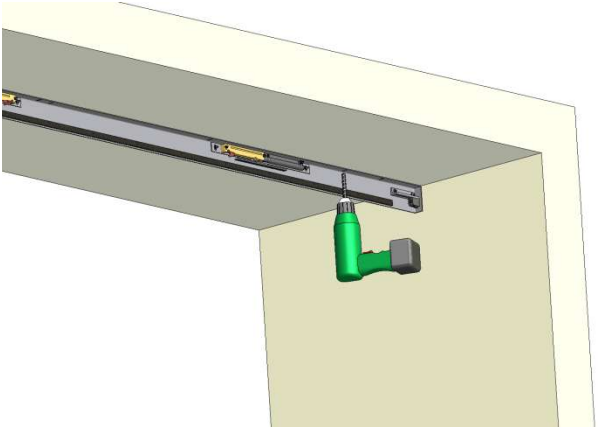
	<p>3 Mounting the rail</p> <p>Mount the rail to the floor by using MWE mounting material. Please control the horizontal adjustment of the rail by means of the water level. Even up, if necessary.</p>
	<p>4 First ceiling drilling</p> <p>Drill the external hole into the ceiling in accordance with your detailed planning. Use the 10 mm diameter drill.</p>
	<p>5 Further ceiling drillings</p> <p>Mount loosely the external fastening of the ceiling guide (including preinstalled door stops). See step # 6. Put the ceiling guide in a parallel position to the floor rail. Use the ceiling guide as your "drilling template" to pre-drill further holes by using the 6 mm diameter drill. Redrill the holes by 10 mm diameter drill.</p>

Installation instructions

System Terra M feat. Softstop (ST.1062.TM)

Am Steinbusch 7
D - 48351 Everswinkel
Tel.: +49(0)2582-9960- 0
Tel.: +49(0)2582-9960-128
Internet: www.mwe.de

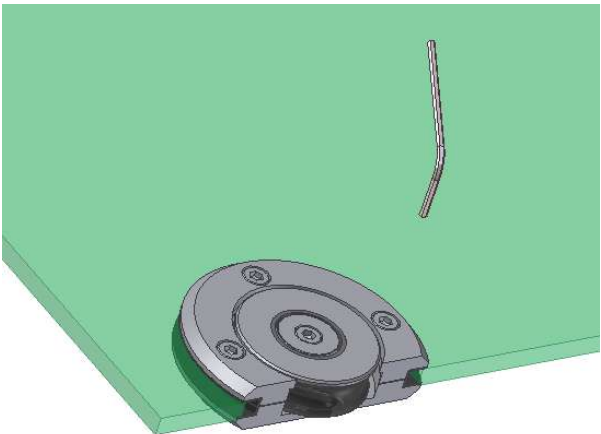
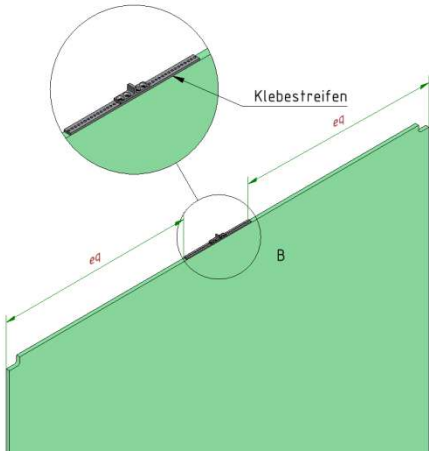
	<p>6 Mounting the ceiling guide</p> <p>Mount the ceiling guide to the ceiling by using MWE mounting material. Please control the horizontal adjustment of the guide by means of the water level. Even up, if necessary.</p>
	<p>7 Installation of the carriages</p> <p>Put the door panel on a mounting rack having the hardware face upwards. Loosen the 3 screws from the carriage case. Put the carriage casing into the prepared glass cut out. Please pay attention that casing border and glass are flush. As next step fasten the casing screws.</p>
	<p>8 Affixing the catch</p> <p>At first mark the center point of the glass panel. Then remove the protective film of the sticky tape on the lower side of the catch. Affix the mounting plate with the pre-assembled catch in the center at the upper edge of the door panel.</p>

Installation instructions

System Terra M feat. Softstop (ST.1062.TM)

Am Steinbusch 7
D - 48351 Everswinkel
Tel.: +49(0)2582-9960- 0
Tel.: +49(0)2582-9960-128
Internet: www.mwe.de

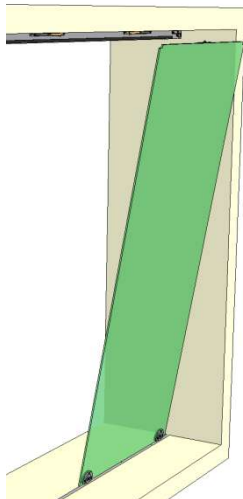

9

Putting up the door panel

Set up the pre-mounted sliding door carefully on the rail. Put up the door at the right angle and rest against the felt on the inner side of the guide profile.

ATTENTION!

Please make sure the glass panel is continuously supported by a 2nd person until screwing is finished.

The gap between the catch and the lower edge of the damper should be circa **0.5 mm**. The damper **must be pre-loaded** before the very first use!

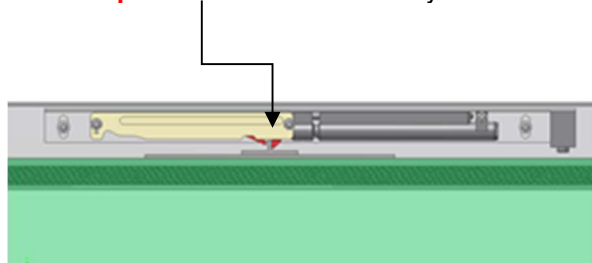

10

Adjusting the Soft-Stop

The height of the Soft-Stop mechanism can be adjusted by using the long slots in the mounting plate.

To achieve a perfect functionality make the distance between the catch's upper edge and the lower edge of the Soft-Stop at approximately 2 mm.

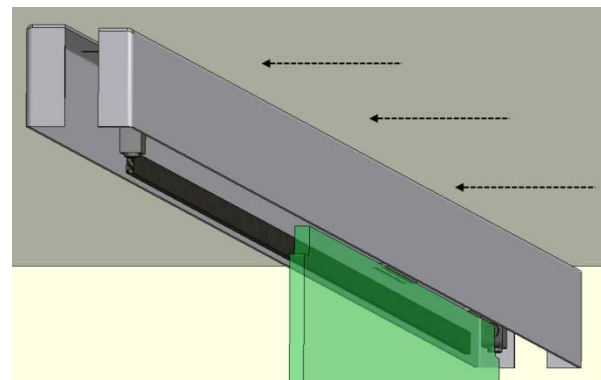

11

Installation of the inner guide profile

The second half of the guide profile can be put into the first one now. The slots thereby receive the threaded bolts at the upper side of the outside profile. Please screw both profile parts by using the attached nuts.

Installation instructions

System Terra M feat. Softstop (ST.1062.TM)

Am Steinbusch 7
D - 48351 Everswinkel
Tel.: +49(0)2582-9960- 0
Tel.: +49(0)2582-9960-128
Internet: www.mwe.de

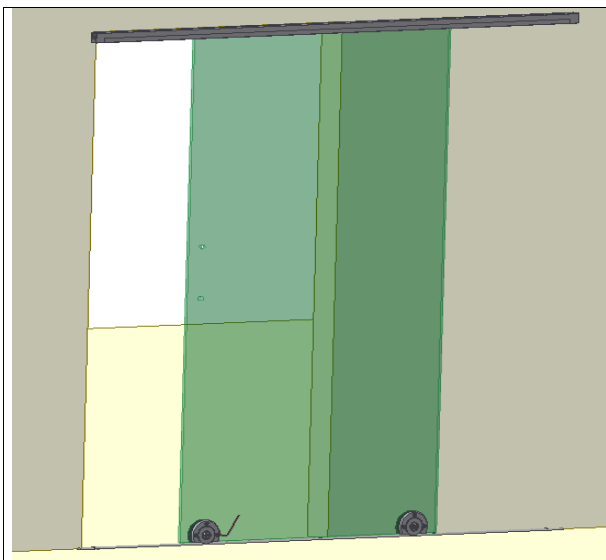

12

Final control of the sliding door

Control the smooth sliding of the door, the function of the door stops and the safety pin. Please adjust, if necessary. Install door handles or flush pulls respectively.

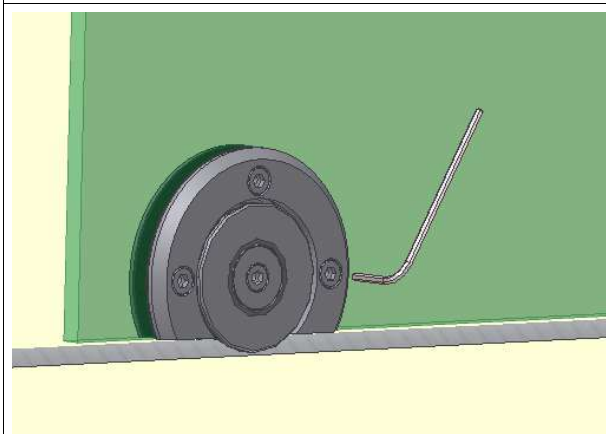

13

Tightening the bolts

Once the installation is completed, make sure that every single bolt is once again securely tightened!