

Technical drawings are subject to change without notice.
 All millimeter dimensions are exact and supersede inch conversions.

Copyright MWE NA Inc., all rights reserved. Reproduction or other use of these designs without written consent from MWE NA Inc. is prohibited.

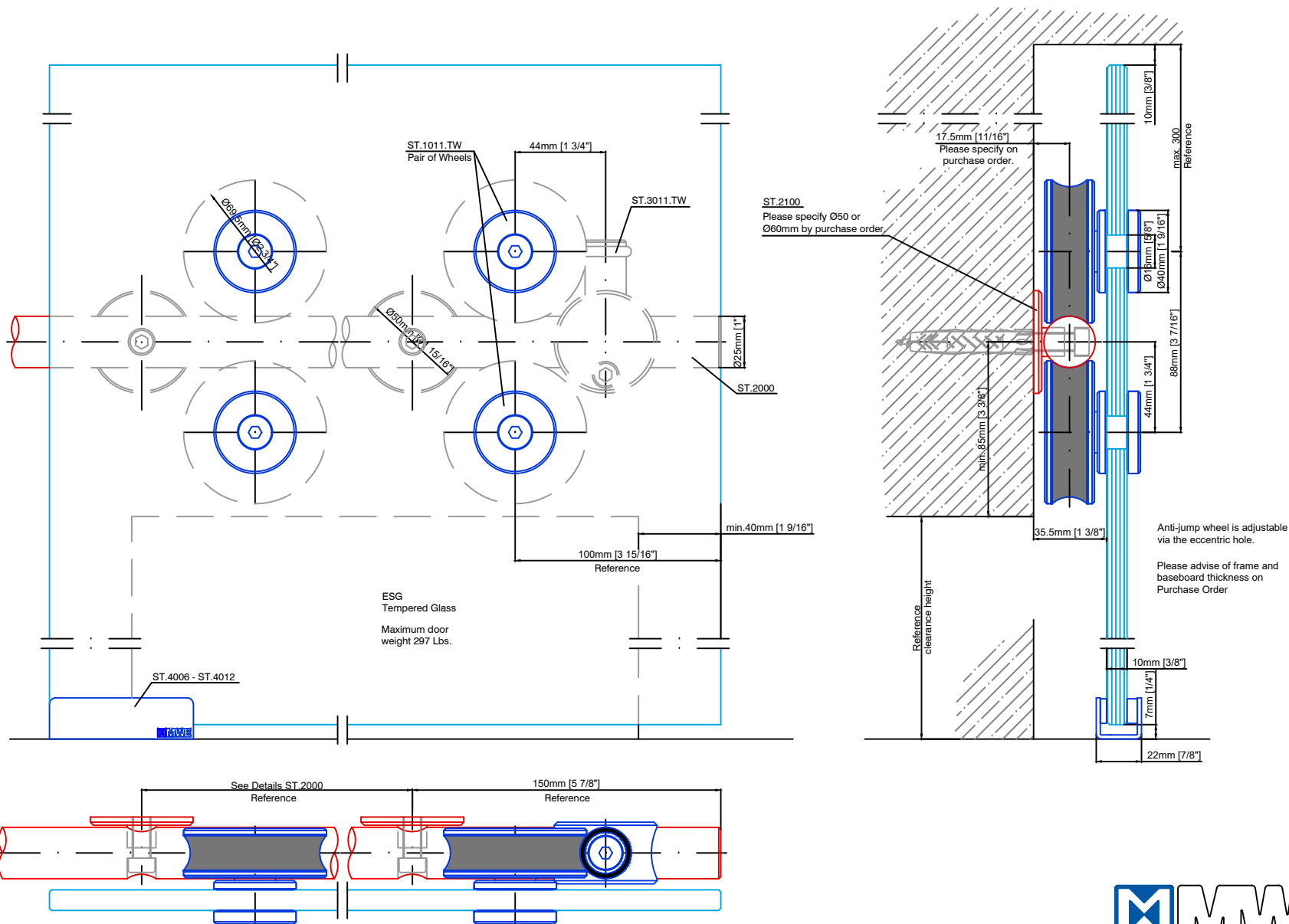

Twin ST.1011.TW

Date Prepared: July 2018

Prepared By: CDA | JRT



Email: info@mwe-na.com
www.mwe-na.com

Technical drawings are subject to change without notice.
All millimeter dimensions are exact and supersede inch conversions.

Copyright MWE NA Inc., all rights reserved. Reproduction or other use of these designs without written consent from MWE NA Inc. is prohibited.

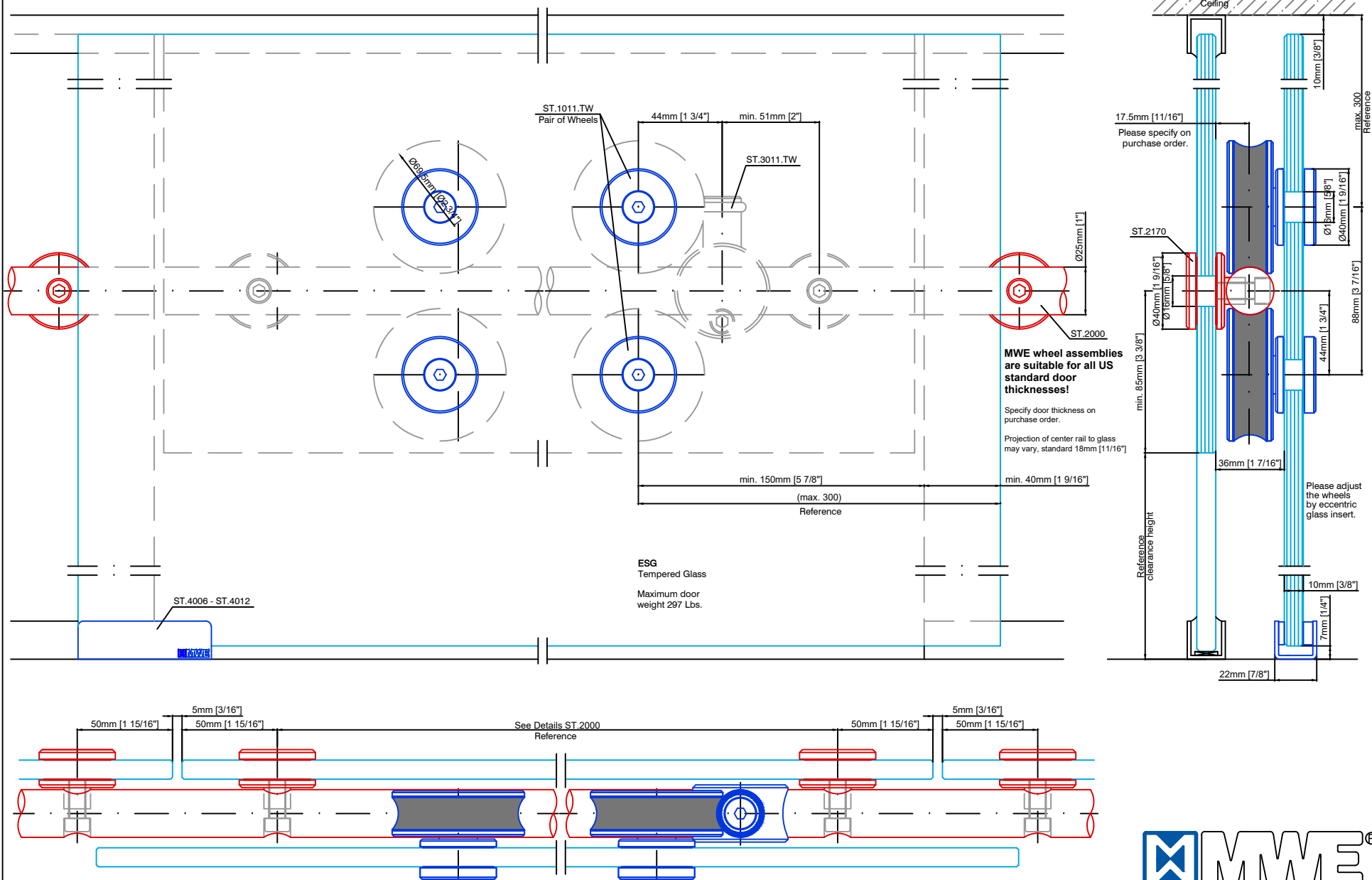

Twin ST.1011.TW

Date Prepared: July 2018

Prepared By: CDA | JRT



Email: info@mwe-na.com
www.mwe-na.com

Technical drawings are subject to change without notice.
 All millimeter dimensions are exact and supersede inch conversions.

Copyright MWE NA Inc., all rights reserved. Reproduction or other use of these designs without written consent from MWE NA Inc. is prohibited.

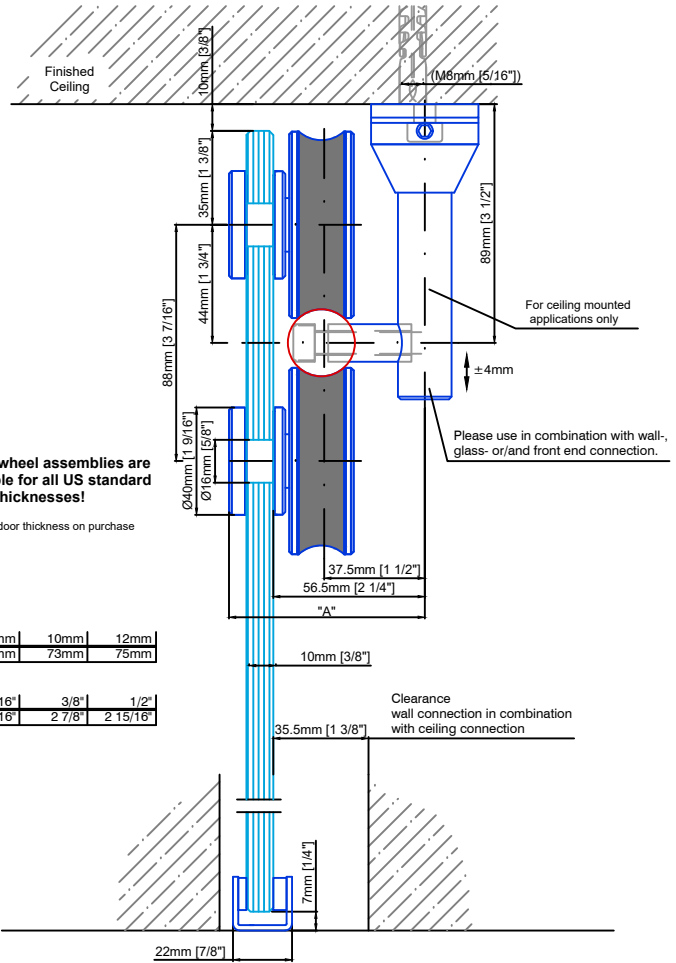
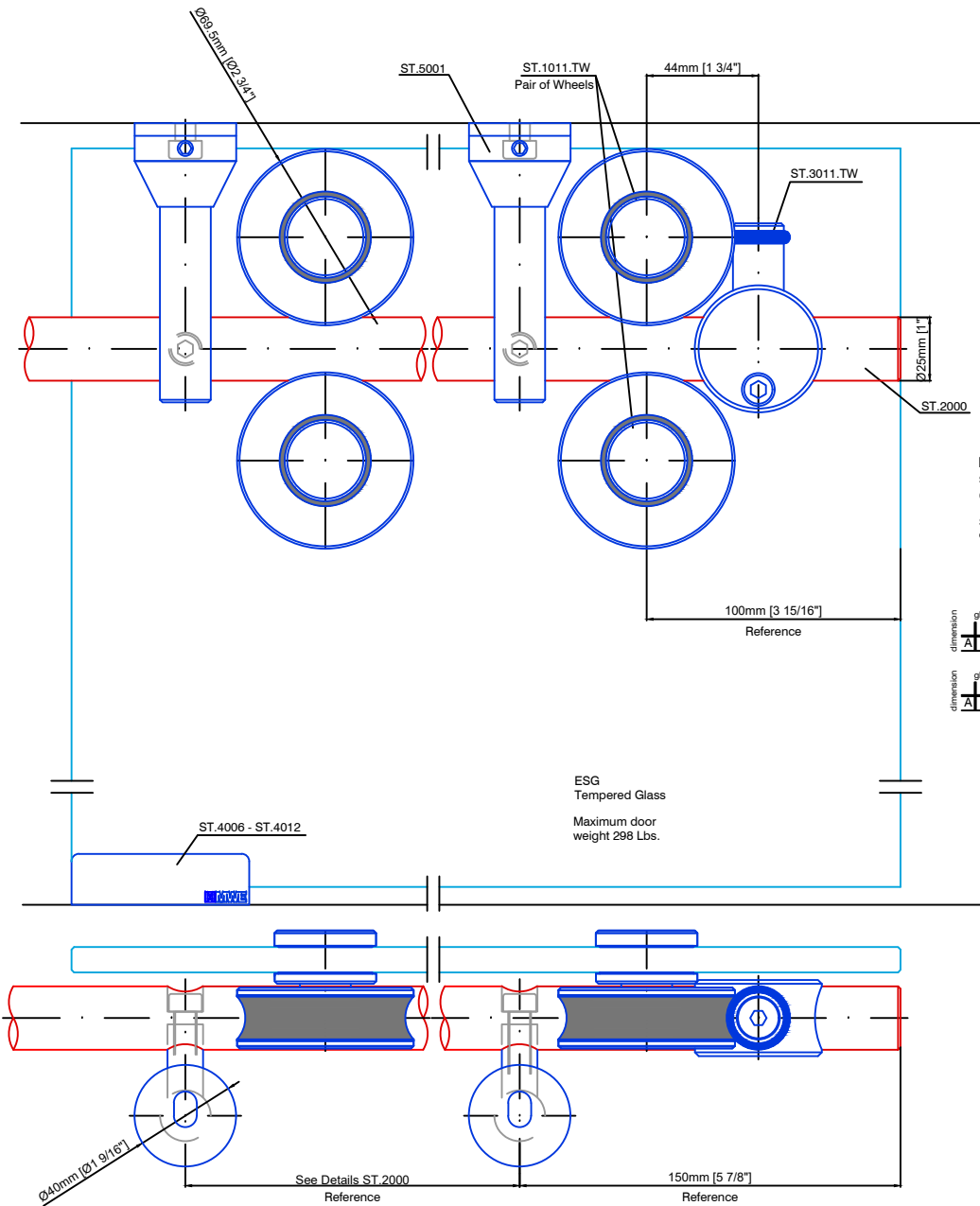

MWE wheel assemblies are suitable for all US standard door thicknesses!

Specify door thickness on purchase order.

dimension	glass	8mm	10mm	12mm
A		71mm	73mm	75mm

dimension	glass	5/16"	3/8"	1/2"
A		2 13/16"	2 7/8"	2 15/16"

Twin ST.1011.TW

Date Prepared: July 2018 | Prepared By: CDA | JRT



Email: info@mwe-na.com
www.mwe-na.com

Z:\MWE-NA Network\Technical Specifications_2018

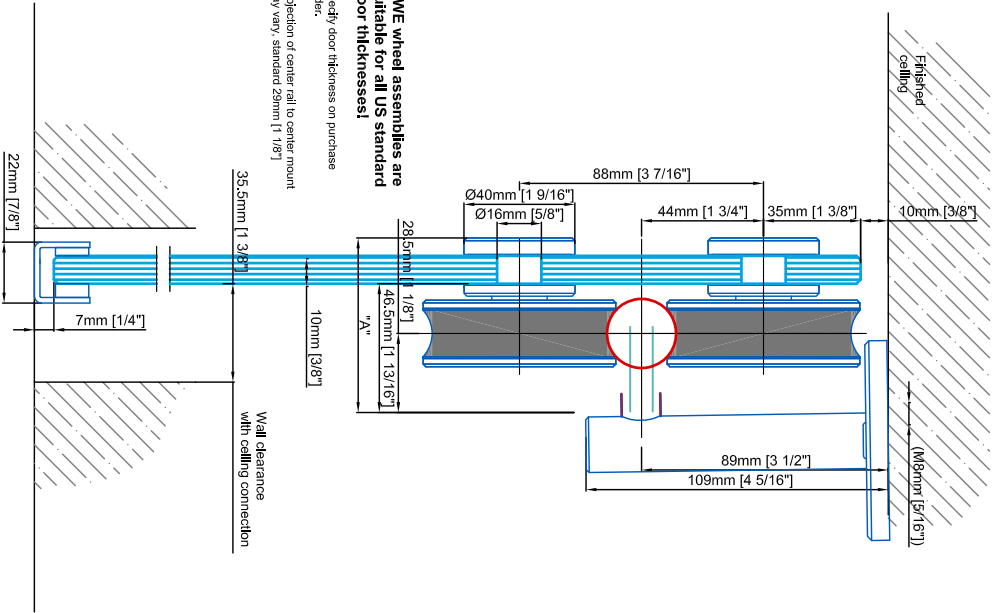
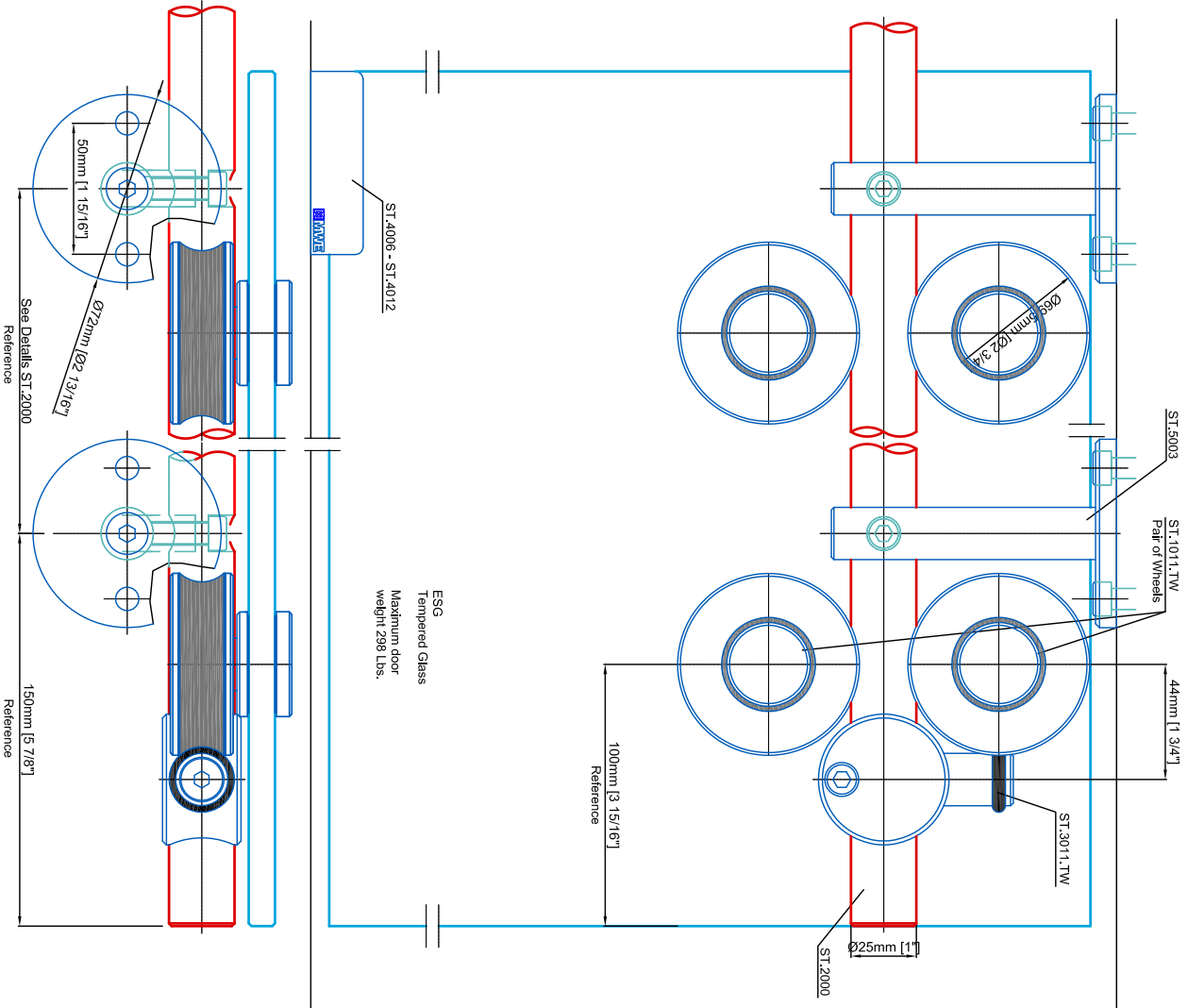

dimension	Glass	Glass	Glass
A	8mm	10mm	12mm
A	61mm	63mm	65mm
A	5/16"	3/8"	1/2"
A	2 3/8"	2 1/2"	2 9/16"

Twin ST.1011.TW

Date Prepared: March 2019

Prepared By: CDA



T e l . : 9 5 4 - 9 8 2 - 6 5 9 5
E m a i l : s a l e s @ m w e - n a . c o m
www.mwe-na.com

Technical drawings are subject to change without notice.
All millimeter dimensions are exact and supersede inch conversions.

Copyright MWE NA Inc., all rights reserved. Reproduction or other use of these designs without written consent from MWE NA Inc. is prohibited.

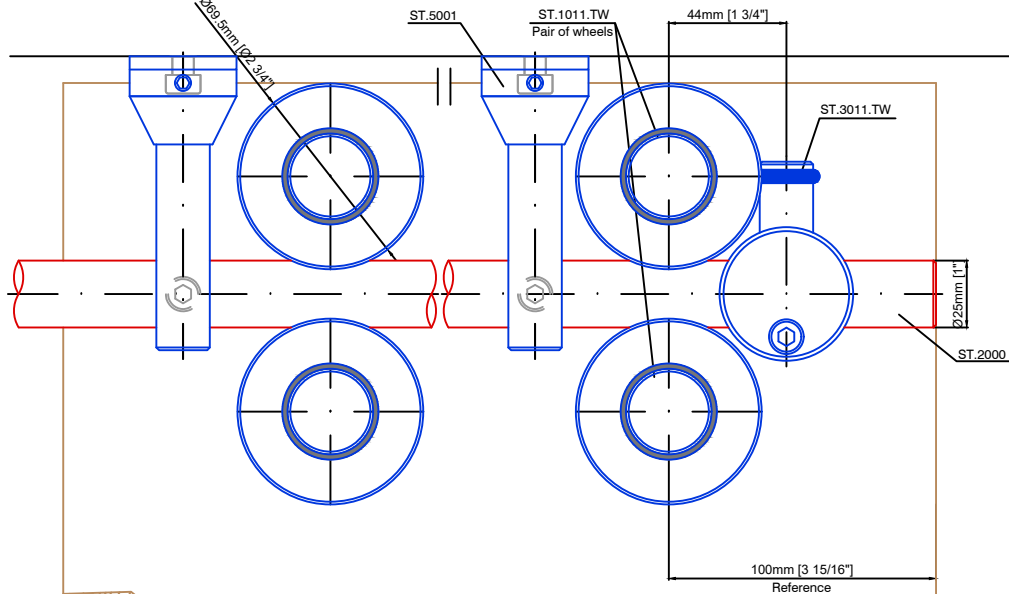

MWE wheel assemblies are suitable for all US standard door thicknesses!
Specify door thickness on purchase order.

Please adjust the rollers by eccentric glass insert.
Please notice the frame and baseboard dimensions on planning.

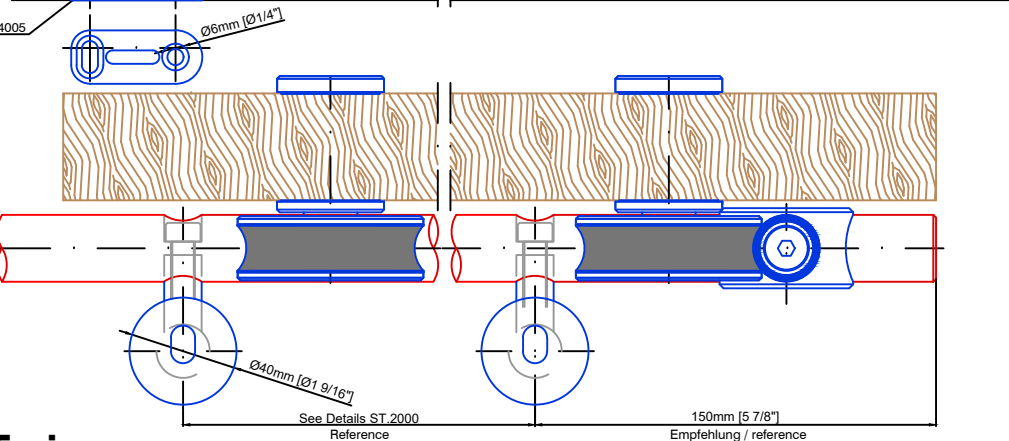
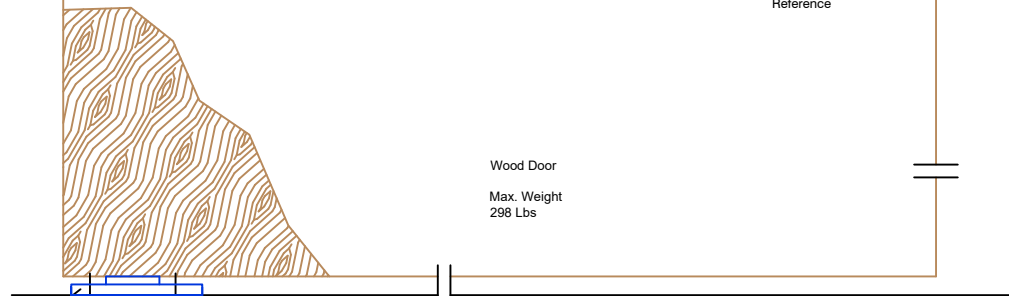
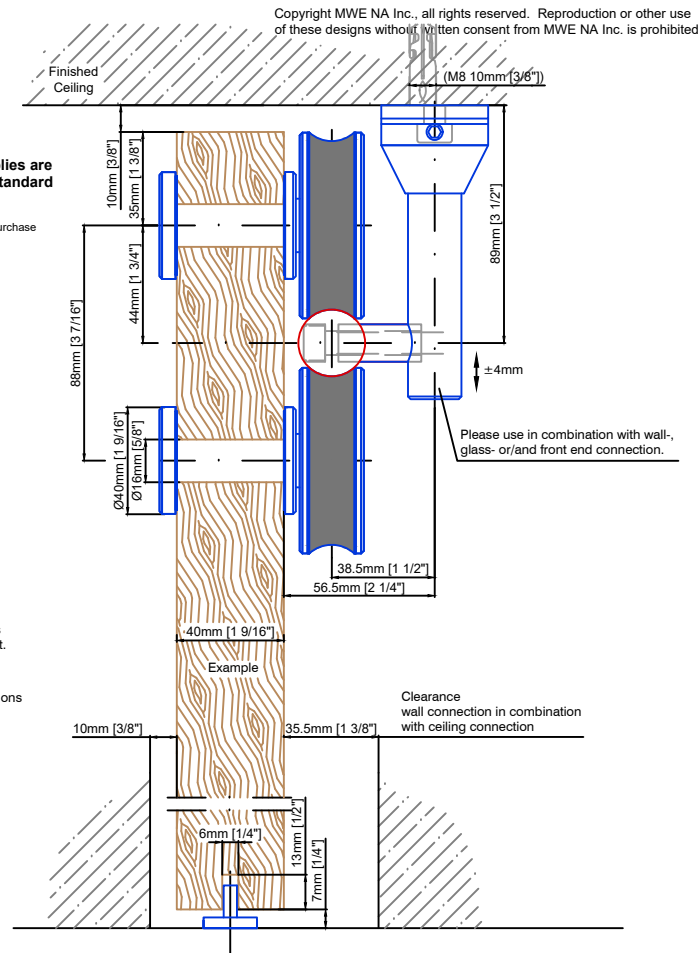

Twin ST.1011.TW

Date Prepared: July 2018

Prepared By: CDA | JRT



Email: info@mwe-na.com
www.mwe-na.com